

LAY-ON TYPE SINK MODEL(DOUBLE)

SD900



- ◆ D : 900x550
- ◆ B : 340x390x170 / 340x390x170
- ◆ Outlet Hole : 89 ϕ x2

PSD900



- ◆ D : 900x550
- ◆ B : 390x340x170 / 340x390x170
- ◆ Outlet Hole : 89 ϕ x2

XLSD900



- ◆ D : 900x600
- ◆ B : 340x390x170 / 340x390x170
- ◆ Outlet Hole : 89.162 ϕ

SD1000 (L/R)

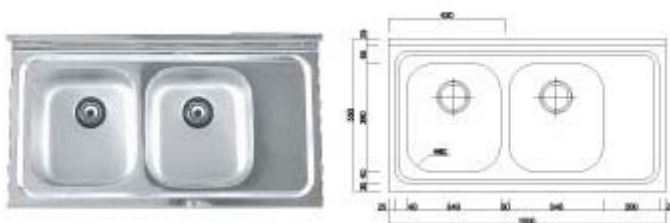

- ◆ D : 1000x550
- ◆ B : 340x390x170 / 340x390x170
- ◆ Outlet Hole : 89 ϕ x2

SD1100 (L/R)

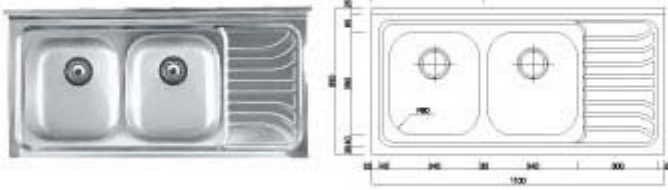

- ◆ D : 1100x550
- ◆ B : 340x390x170 / 340x390x170
- ◆ Outlet Hole : 89 \varnothing x2

SD1200 (L/R)

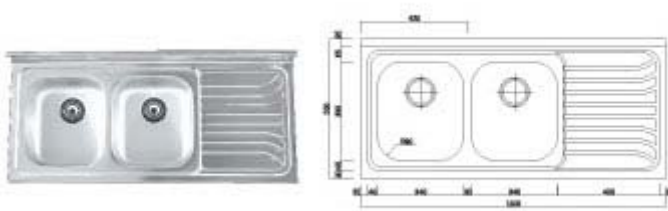

- ◆ D : 1200x550
- ◆ B : 340x390x170 / 340x390x170
- ◆ Outlet Hole : 89 \varnothing x2

LSD1200 (L/R)

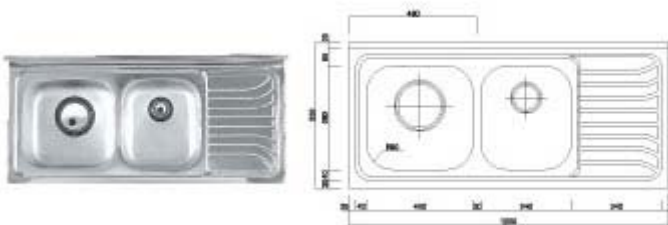

- ◆ D : 1200x550
- ◆ B : 400x390x170 / 340x390x170
- ◆ Outlet Hole : 89.162 \varnothing

SDH1200 (L/R)

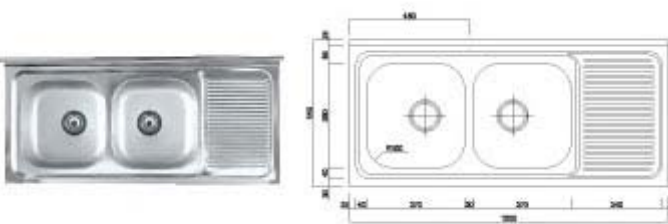

- ◆ D : 1100x490
- ◆ B : 370x390x170 / 370x390x170
- ◆ Outlet Hole : 89 \varnothing x2

PSD1200 (L/R)

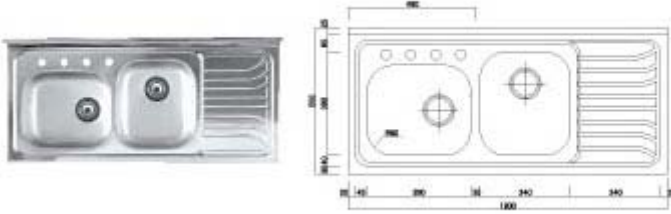

- ◆ D : 1200x490
- ◆ B : 390x340x170 / 340x390x170
- ◆ Outlet Hole : 89 \varnothing x2

NSD1200 (L/R)

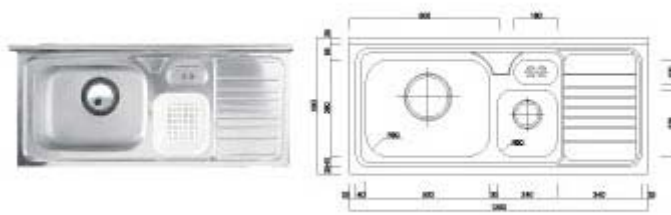

- ◆ D : 1200x490
- ◆ B : 500x390x170 / 240x270x130
- ◆ Outlet Hole : 89.162 \varnothing

XLSD1200 (L/R)

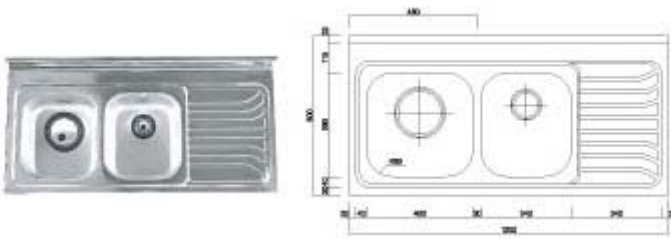

- ◆ D : 1200x600
- ◆ B : 400x390x170 / 340x390x130
- ◆ Outlet Hole : 89.162 \varnothing

SD1500 (L/R)

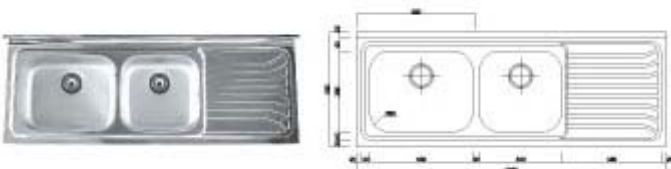

- ◆ D : 1500x550
- ◆ B : 500x390x170 / 400x390x130
- ◆ Outlet Hole : 89 \varnothing x2

XLSD1500 (L/R)



- ◆ D : 1500x600
- ◆ B : 500x390x170 /400x390x130
- ◆ Outlet Hole : 89.162 \varnothing

LSD1800 (L/R)



- ◆ D : 1800x600
- ◆ B : 400x390x170 /340x390x130
- ◆ Outlet Hole : 89.162 \varnothing

XLSD1800 (L/R)



- ◆ D : 1800x600
- ◆ B : 400x390x170 /340x390x130
- ◆ Outlet Hole : 89.162 \varnothing

DAEKWANG TRADING CO., LTD.

NO. 1107 ROSEDALE B/D, 724 SUSEO-DONG, KANGNAM-KU,
SEOUL, KOREA

TEL : +82-2-3413-2915

FAX : +82-2-3413-2917

e-mail : daekwang@net-biz.co.kr

home : <http://www.net-biz.co.kr>

LAY-ON TYPE SINK MODEL(SINGLE)

PSS600

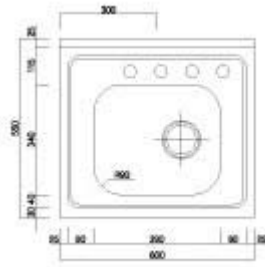

- ◆ D : 600x550
- ◆ B : 390x340x175
- ◆ Outlet Hole : 89 \varnothing

SS600

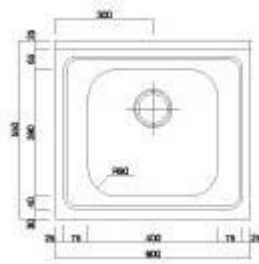

- ◆ D : 600x550
- ◆ B : 400x390x175
- ◆ Outlet Hole : 89 \varnothing

SS700 (L/R)

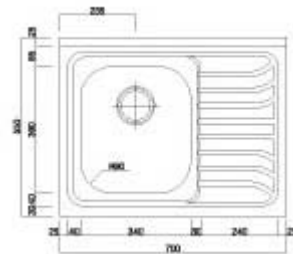

- ◆ D : 700x550
- ◆ B : 340x390x175
- ◆ Outlet Hole : 89 \varnothing

SS800 (L/R)

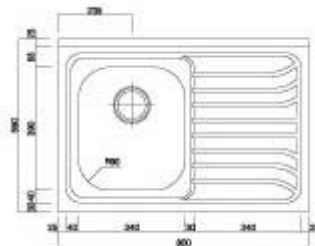

- ◆ D : 800x550
- ◆ B : 340x390x175
- ◆ Outlet Hole : 89 \varnothing

SS900 (L/R)

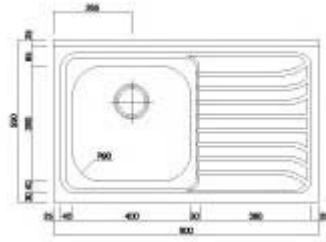

- ◆ D : 900x550
- ◆ B : 400x390x175
- ◆ Outlet Hole : 89 \varnothing

PSS900 (L/R)

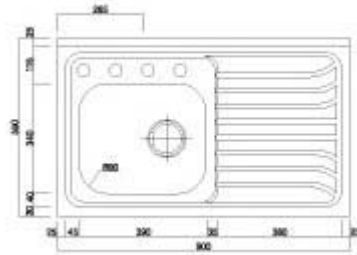

- ◆ D : 900x550
- ◆ B : 390x340x175
- ◆ Outlet Hole : 89 \varnothing

SSL900 (L/R)

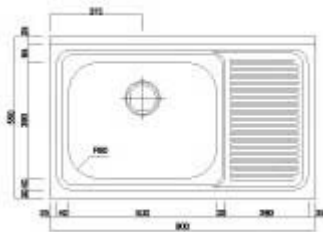

- ◆ D : 900x550
- ◆ B : 500x390x175
- ◆ Outlet Hole : 89 \varnothing

XSS1000 (L/R)

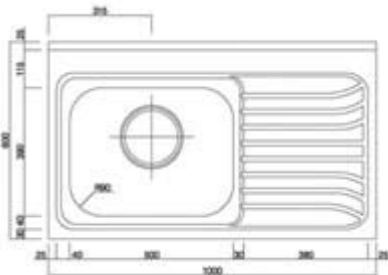

- ◆ D : 1000x600
- ◆ B : 500x390x175
- ◆ Outlet Hole : 162 \varnothing

SS1000 (L/R)

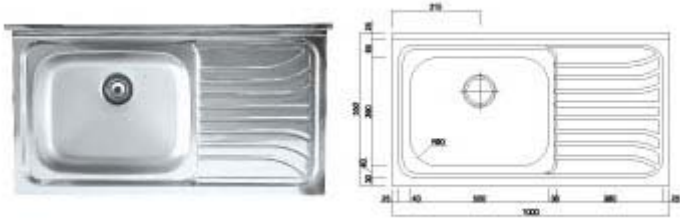

- ◆ D : 1000x550
- ◆ B : 500x390x175
- ◆ Outlet Hole : 89 \varnothing

SS1100 (L/R)

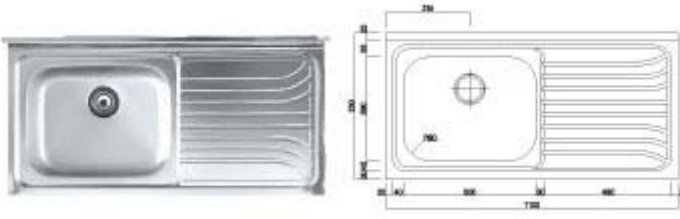

- ◆ D : 1100x550
- ◆ B : 500x390x175
- ◆ Outlet Hole : 89 \varnothing

SS1200 (L/R)

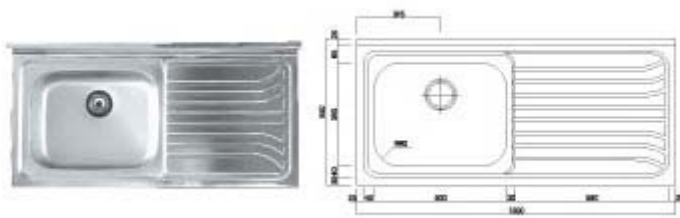

- ◆ D : 1200x550
- ◆ B : 500x390x175
- ◆ Outlet Hole : 89 \varnothing

SSC1200

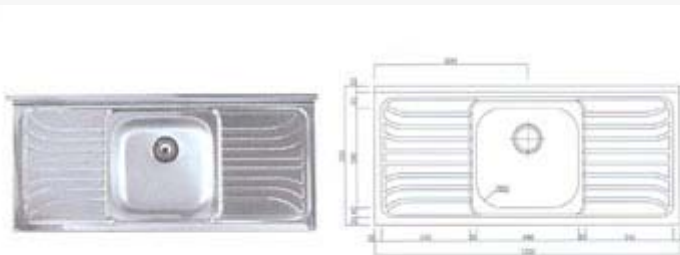

- ◆ D : 1200x550
- ◆ B : 500x390x175
- ◆ Outlet Hole : 89 \varnothing

LAY-ON JUMBO TYPE SINK

JS900

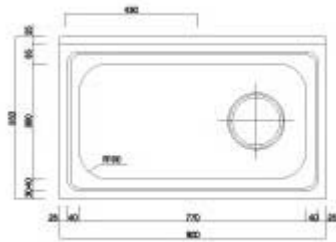

- ◆ D : 900x550
- ◆ B : 770x390x180
- ◆ Outlet Hole : 162 \varnothing

JS1000

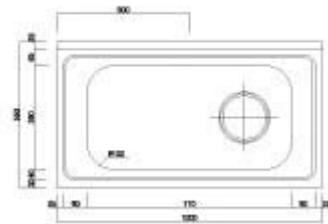

- ◆ D : 1000x550
- ◆ B : 770x390x180
- ◆ Outlet Hole : 162 \varnothing

JS1100 (L/R)

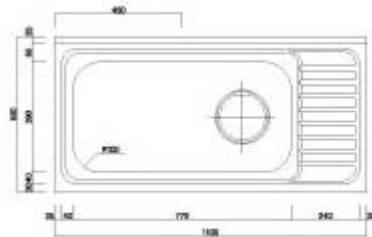

- ◆ D : 1100x550
- ◆ B : 770x390x180
- ◆ Outlet Hole : 162 \varnothing

JSB1100 (L/R)

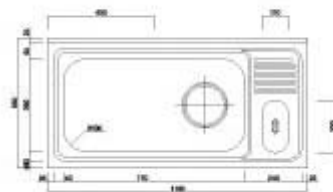

- ◆ D : 1100x550
- ◆ B : 770x390x180
- ◆ Outlet Hole : 162 \varnothing

JS1200 (L/R)

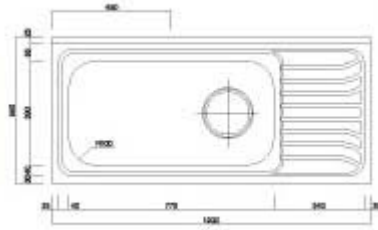

- ◆ D : 1200x550
- ◆ B : 770x390x180
- ◆ Outlet Hole : 162 \varnothing

JSB1200 (L/R)

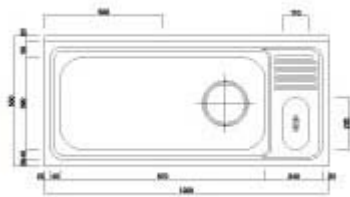

- ◆ D : 1200x550
- ◆ B : 870x390x180
- ◆ Outlet Hole : 162 \varnothing

JS1300 (L/R)

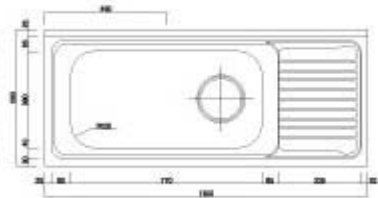

- ◆ D : 1300x550
- ◆ B : 770x390x180
- ◆ Outlet Hole : 162 \varnothing

JS1400 (L/R)

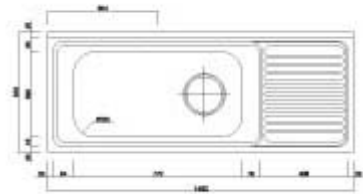

- ◆ D : 1400x550
- ◆ B : 770x390x180
- ◆ Outlet Hole : 162 \varnothing

JS1500 (L/R)

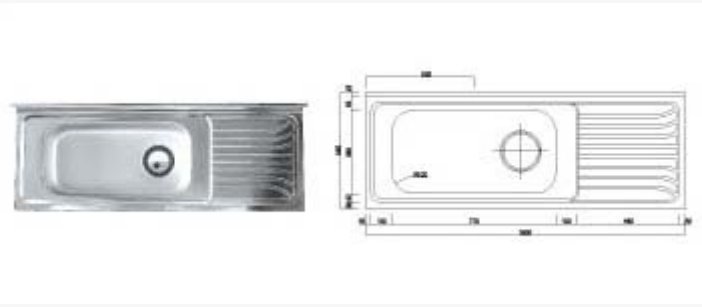

- ◆ D : 1500x550
- ◆ B : 770x390x180
- ◆ Outlet Hole : 162 \varnothing

JS1800 (L/R)



- ◆ D : 1800x550
- ◆ B : 770x390x180
- ◆ Outlet Hole : 162 \varnothing

DAEKWANG TRADING CO., LTD.
NO. 1107 ROSEDALE B/D, 724 SUSEO-DONG, KANGNAM-KU,
SEOUL, KOREA
TEL : +82-2-3413-2915
FAX : +82-2-3413-2917
e-mail : daekwang@net-biz.co.kr
home : <http://www.net-biz.co.kr>

INSET TYPE SINK MODEL

ISS480

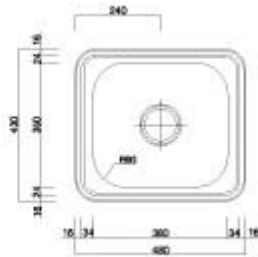

- ◆ D : 480x430
- ◆ B : 380x350x165
- ◆ Outlet Hole : 162 ϕ

ISS520

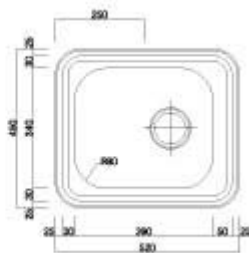

- ◆ D : 520x450
- ◆ B : 390x340x170
- ◆ Outlet Hole : 162 ϕ

ISS630

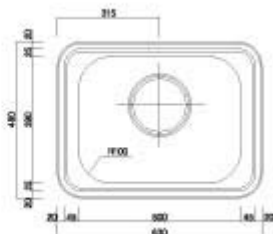

- ◆ D : 630x480
- ◆ B : 500x390x175
- ◆ Outlet Hole : 162 ϕ

ISB630

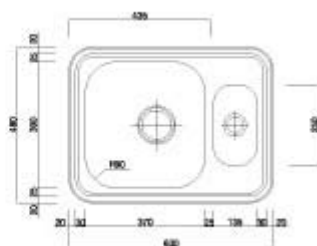

- ◆ D : 630x480
- ◆ B : 370x390x175
- ◆ Outlet Hole : 162 ϕ

ISS870

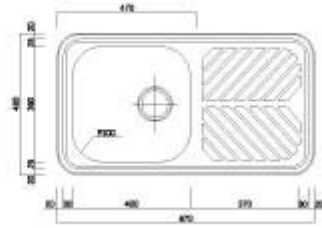

- ◆ D : 870x480
- ◆ B : 370x390x175
- ◆ Outlet Hole : 89 \varnothing

ISS1000

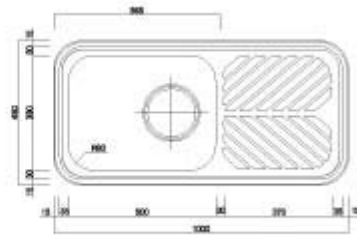

- ◆ D : 1000x480
- ◆ B : 500x390x175
- ◆ Outlet Hole : 162 \varnothing

IST1000

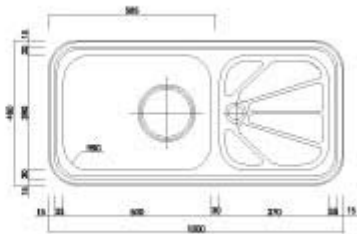

- ◆ D : 1000x480
- ◆ B : 500x390x170
- ◆ Outlet Hole : 162 \varnothing

ISD870

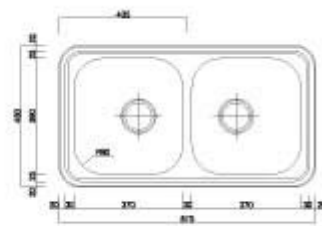

- ◆ D : 870x480
- ◆ B : 370x390x175
/500x390x175
- ◆ Outlet Hole : 89 \varnothing x2

NISD870 (L/R)



◆ D : 870x480

◆ B : 500x390x175/240x270x130

◆ Outlet Hole : 162.89 ϕ

ISD920



◆ D : 920x450

◆ B : 390x340x175

/390x340x175

◆ Outlet Hole : 89 ϕ x2



◆ D : 1000x480

◆ B : 500x390x185/370x390x170

◆ Outlet Hole : 89.162 ϕ

ISB1100 (L/R)

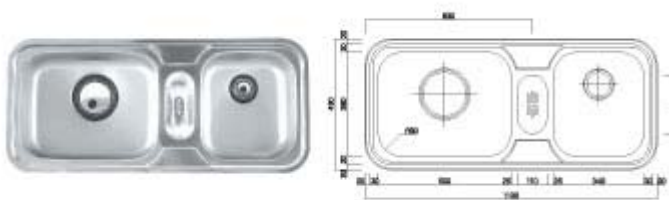

◆ D : 1100x490

◆ B:500x390x175/340x390x175

◆ Outlet Hole : 162.89 ϕ

ISD1100



- ◆ D : 1100x490
- ◆ B : 370x390x175/370x390x175
- ◆ Outlet Hole : 89 \varnothing x2

ISD1145

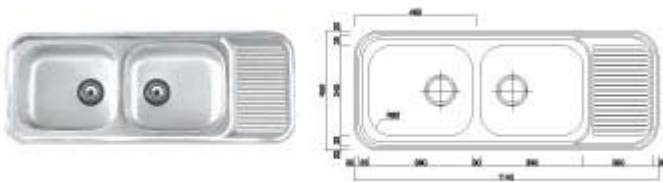

- ◆ D : 1145x450
- ◆ B : 390x340x175/390x340x175
- ◆ Outlet Hole : 89 \varnothing x2

NJIS840

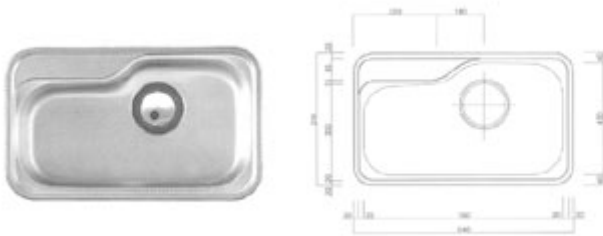

- ◆ D : 840x510
- ◆ B : 760x350x180
- ◆ Outlet Hole : 162 \varnothing

NJIS840p

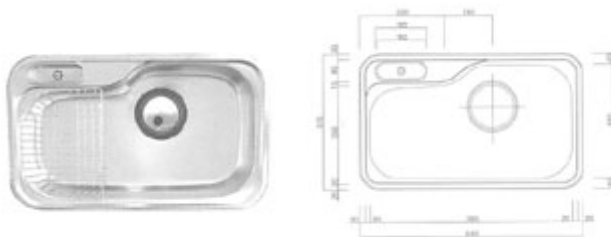

- ◆ D : 840x510
- ◆ B : 760x350x180
- ◆ Outlet Hole : 162 \varnothing

RJIS850

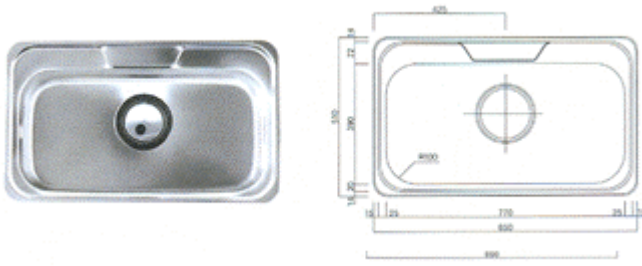

- ◆ D : 850x510
- ◆ B : 770x390x180
- ◆ Outlet Hole : 162 \varnothing

DJIS850

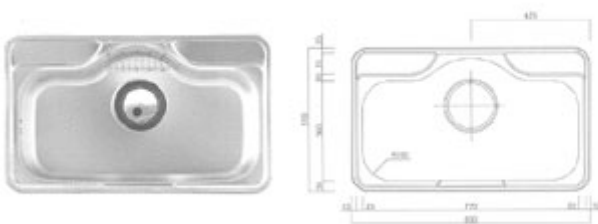

- ◆ D : 850x510
- ◆ B : 770x360x180
- ◆ Outlet Hole : 162 \varnothing

DJIS850p

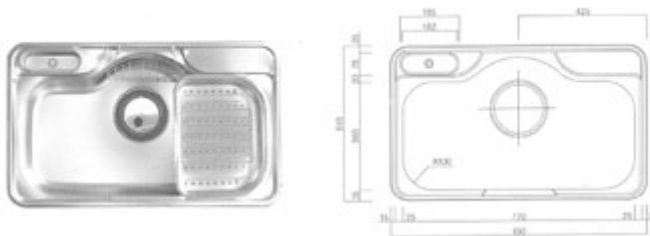

- ◆ D : 850x510
- ◆ B : 770x360x180
- ◆ Outlet Hole : 162 \varnothing

JISB1100

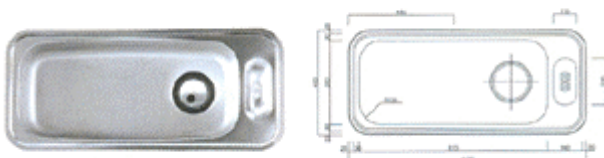

- ◆ D : 1100x490
- ◆ B : 870x390x180
- ◆ Outlet Hole : 162 \varnothing

JIS850

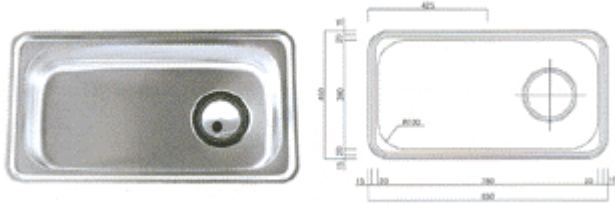

- ◆ D : 850x460
- ◆ B : 780x390x180
- ◆ Outlet Hole : 162 \varnothing

CJIS870

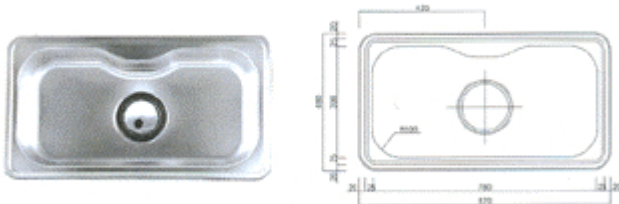

- ◆ D : 870x480
- ◆ B : 780x390x180
- ◆ Outlet Hole : 162 \varnothing

JIS870

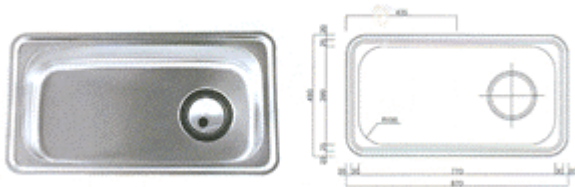

- ◆ D : 870x480
- ◆ B : 770x390x180
- ◆ Outlet Hole : 162 \varnothing

DAEKWANG TRADING CO., LTD.

NO. 1107 ROSEDALE B/D, 724 SUSEO-DONG, KANGNAM-KU,
SEOUL, KOREA

TEL : +82-2-3413-2915

FAX : +82-2-3413-2917

e-mail : daekwang@net-biz.co.kr

home : <http://www.net-biz.co.kr>

BOWL TYPE

B240

- D : 266 × 296
- B : 240 × 270 × 130
- Outlet Hole : 89φ



B340

- D : 368 × 418
- B : 340 × 390 × 175
- Outlet Hole : 89φ



B340L

- D : 368 × 418
- B : 340 × 390 × 175
- Outlet Hole : 162φ



B370

- D : 418 × 398
- B : 390 × 370 × 175
- Outlet Hole : 89φ



B400

- D : 428 × 418
- B : 400 × 390 × 175
- Outlet Hole : 89φ



B400L

- D : 428 × 418
- B : 400 × 390 × 175
- Outlet Hole : 162φ



B500

- D : 528 × 418
- B : 500 × 390 × 175
- Outlet Hole : 89φ



B500L

- D : 528 × 418
- B : 500 × 390 × 175
- Outlet Hole : 162φ



B500S

- D : 528 × 418
- B : 500 × 390 × 175
- Outlet Hole : 162φ



B770

- D : 798 × 418 ■ B : 770 × 390 × 180
- Outlet Hole : 162φ



B870

■ D : 898 × 418 ■ B : 870 × 390 × 180
■ Outlet Hole : 162φ



DAEKWANG TRADING CO., LTD.
NO. 1107 ROSEDALE B/D, 724 SUSEO-DONG, KANGNAM-KU,
SEOUL, KOREA
TEL : +82-2-3413-2915
FAX : +82-2-3413-2917
e-mail : daekwang@net-biz.co.kr
home : <http://www.net-biz.co.kr>